

Jenga

Luca Anzanello
Alberto Drigo

Laboratorio di progetto 2E
a.a. 2021/2022

prof.ssa Esther Giani
prof.ssa Cristiana Cellucci

guest critic
prof. Giancarlo Carnevale

tutor
Alessio Tamiazzo
Valentina Covre

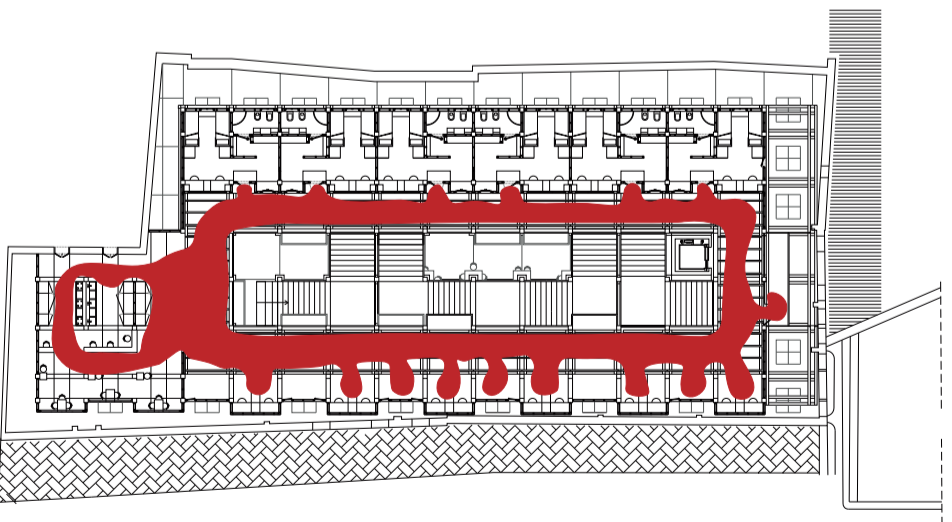
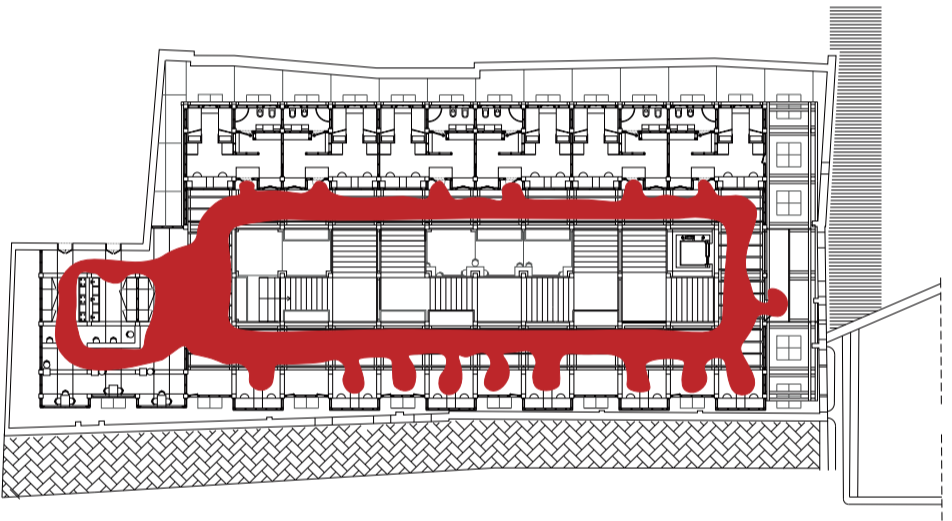
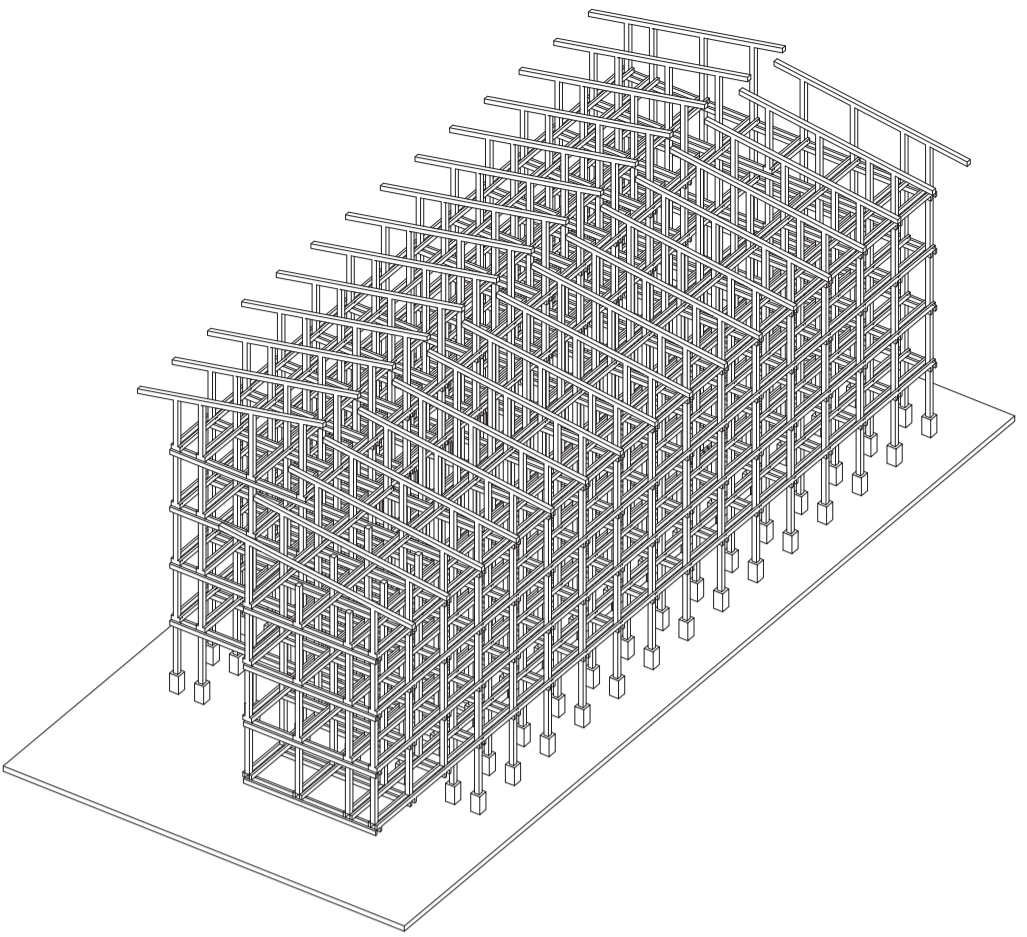

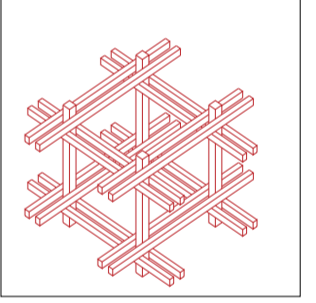
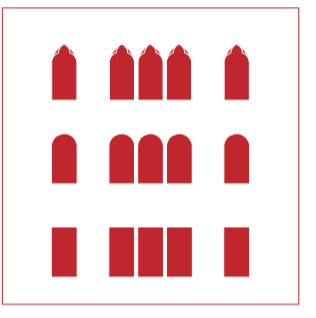
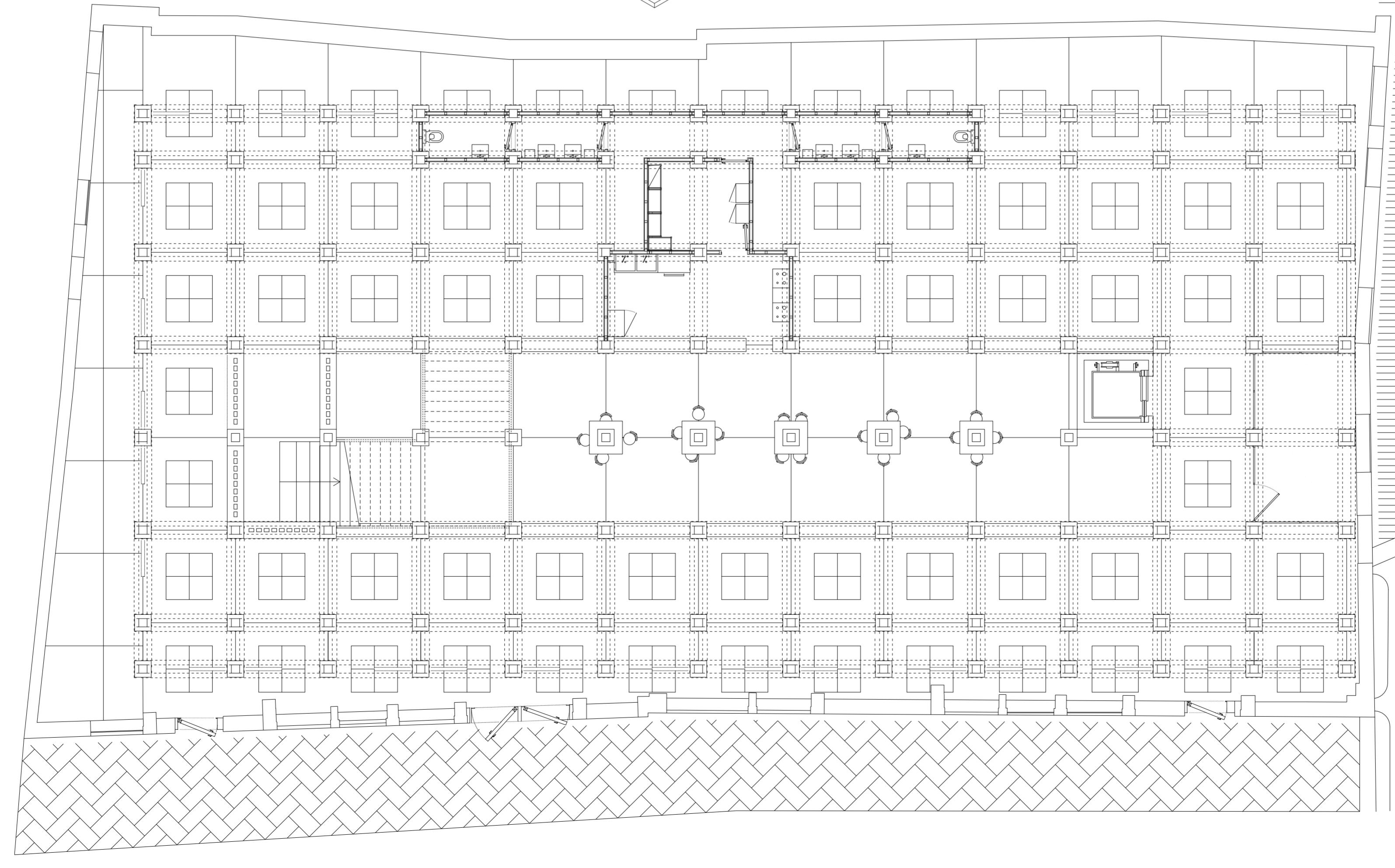
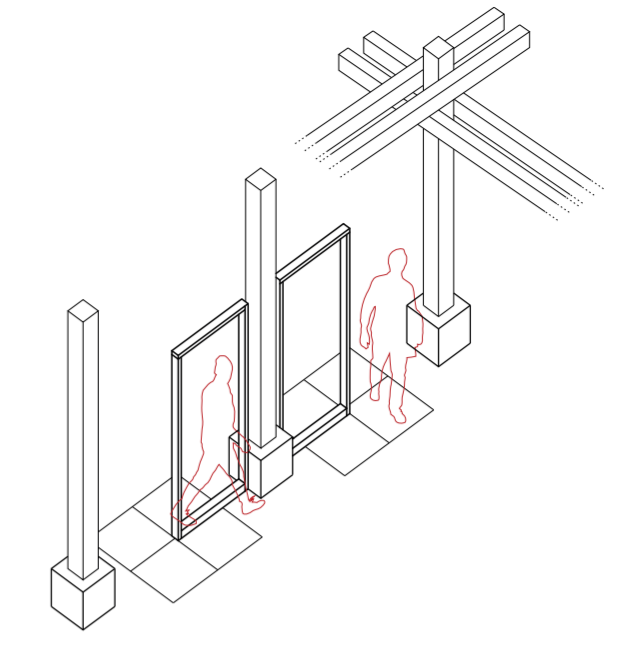
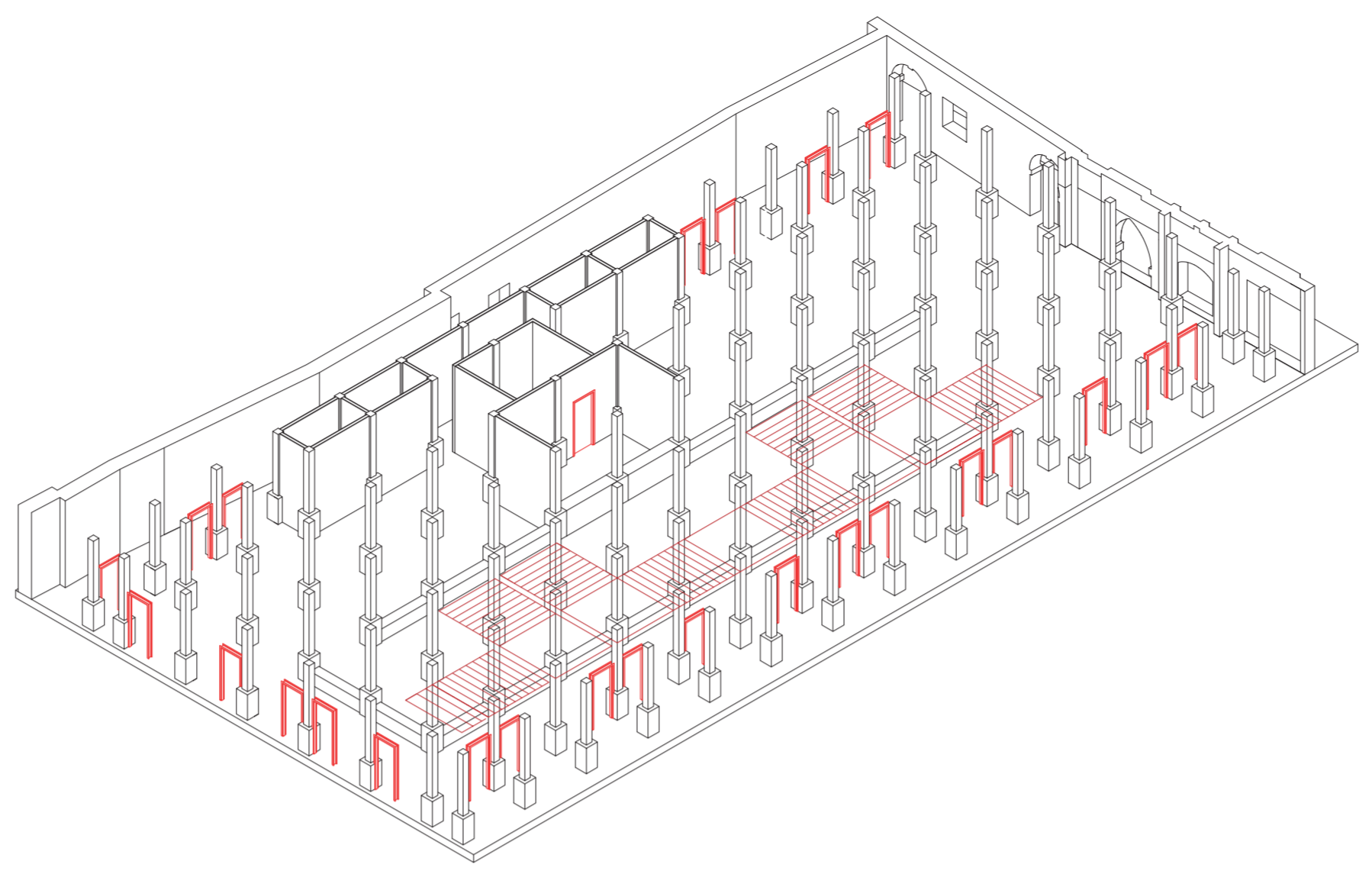
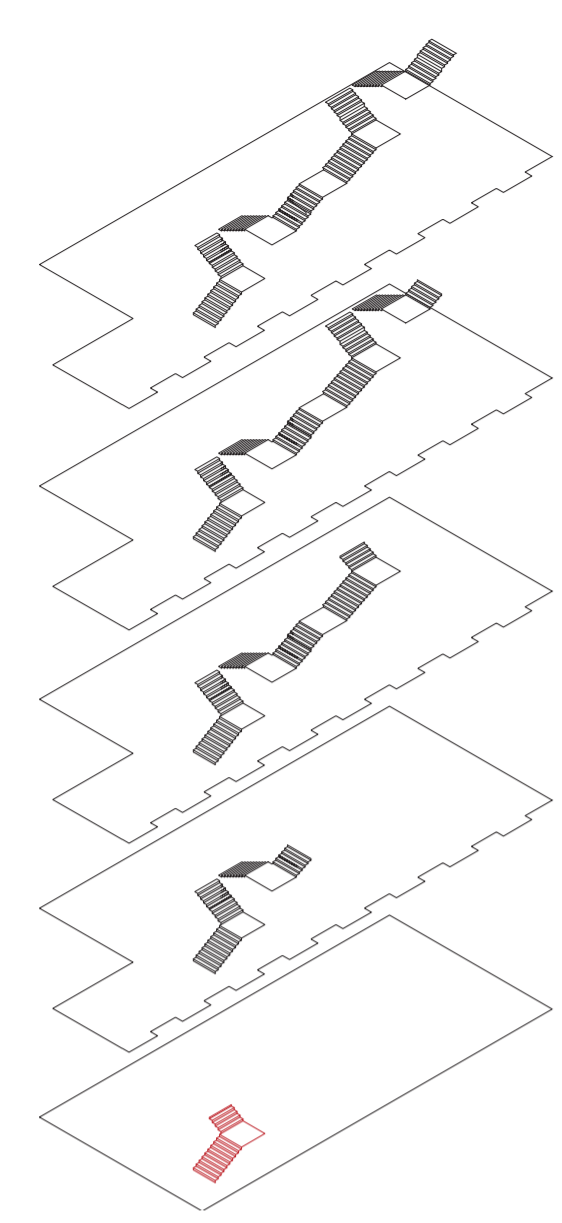

Jenga

Luca Anzanello
Alberto Drigo

Laboratorio di progetto 2E
a.a. 2021/2022

prof.ssa Esther Gianì
prof.ssa Cristiana Cellucci

guest critic
prof. Giancarlo Carnevale

tutor
Alessio Tamiazzo
Valentina Covre

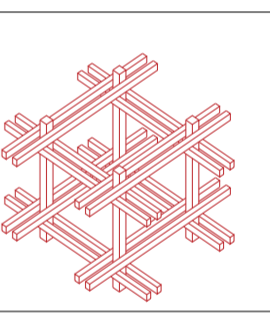
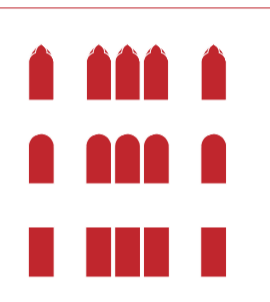
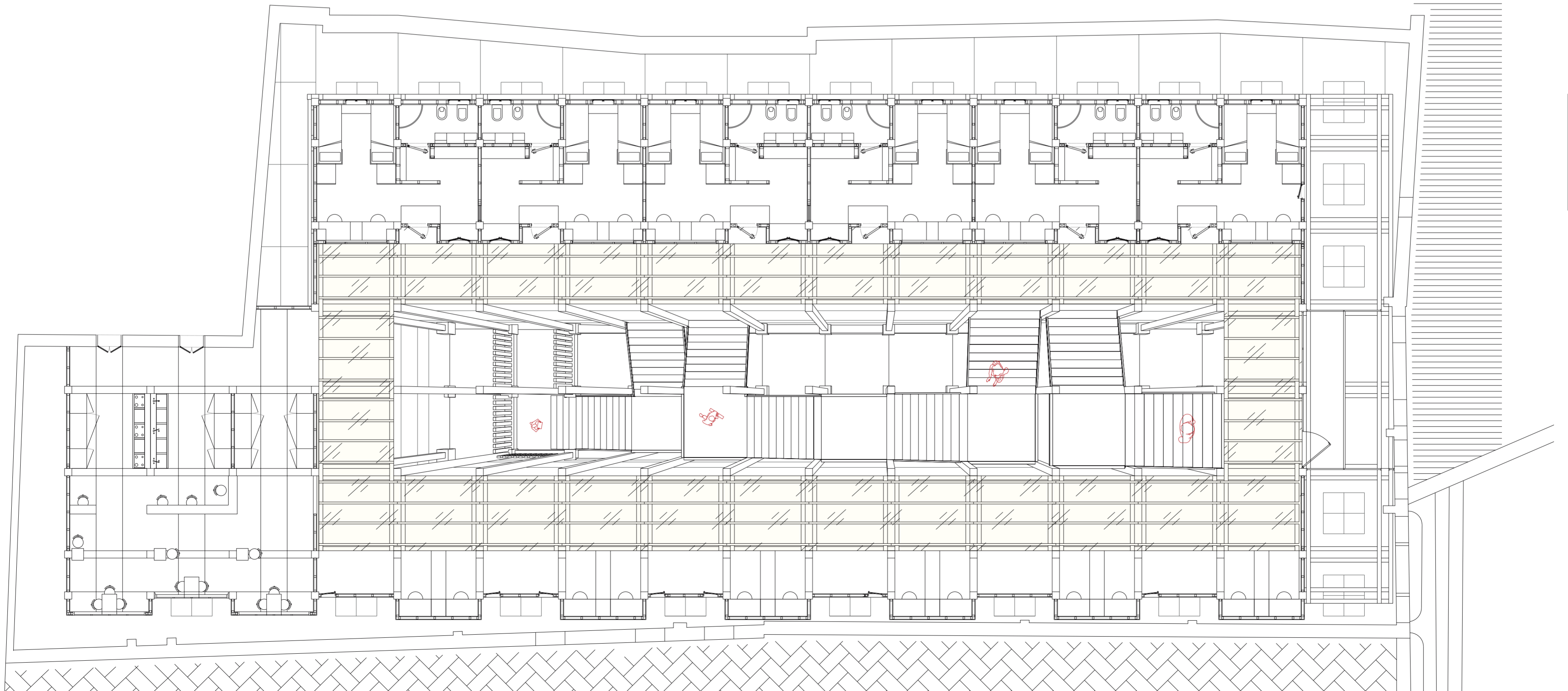
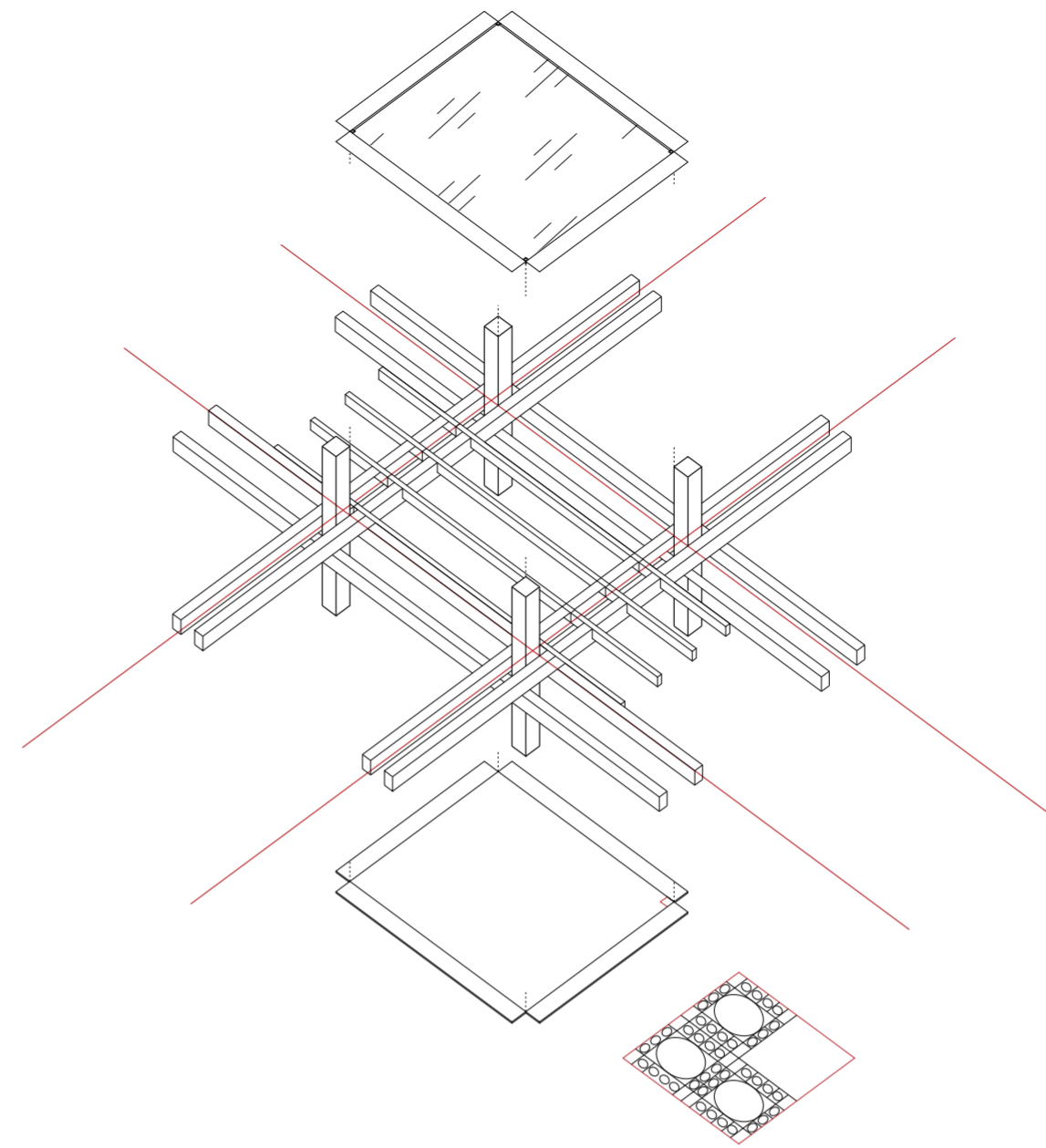
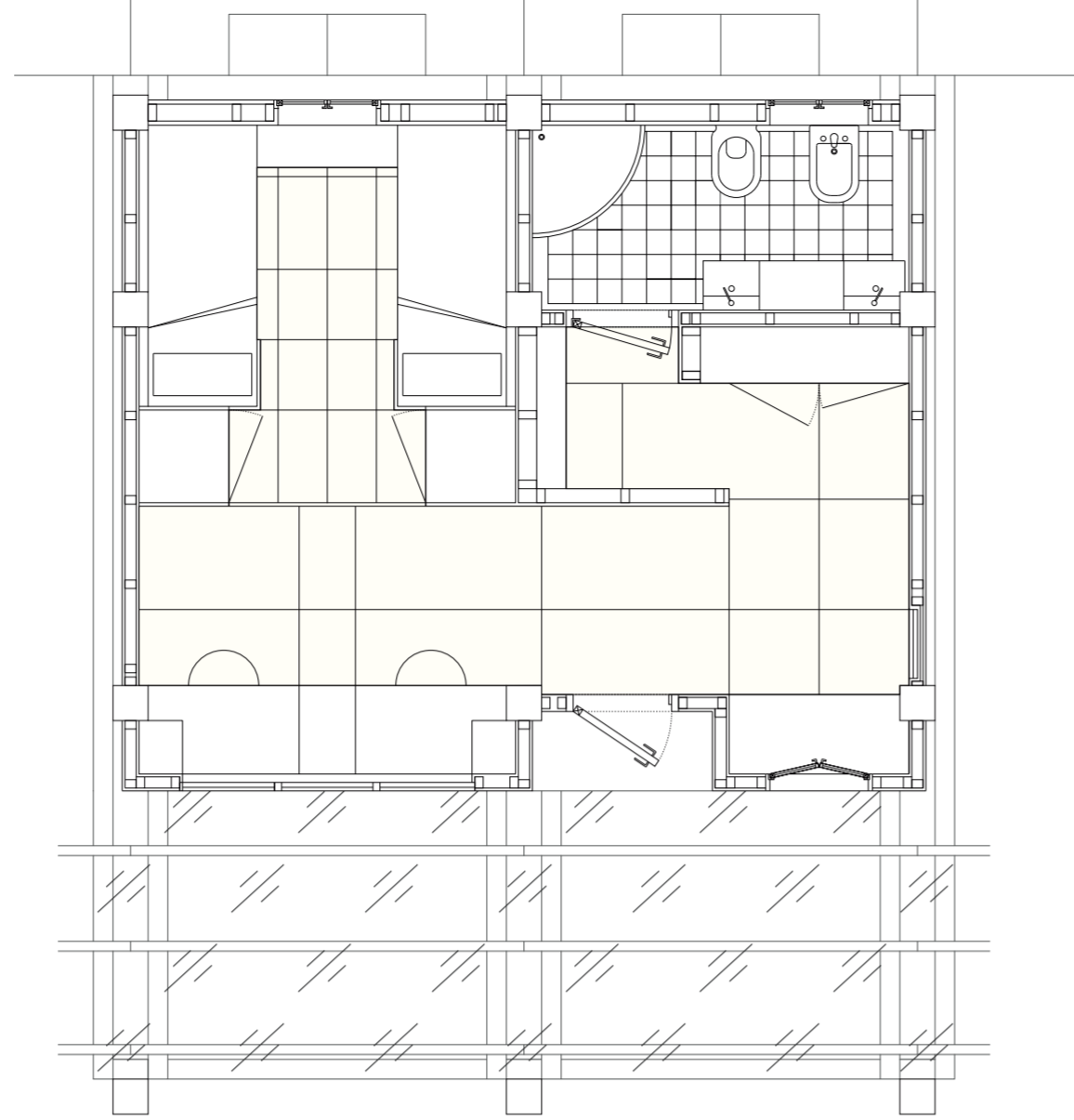
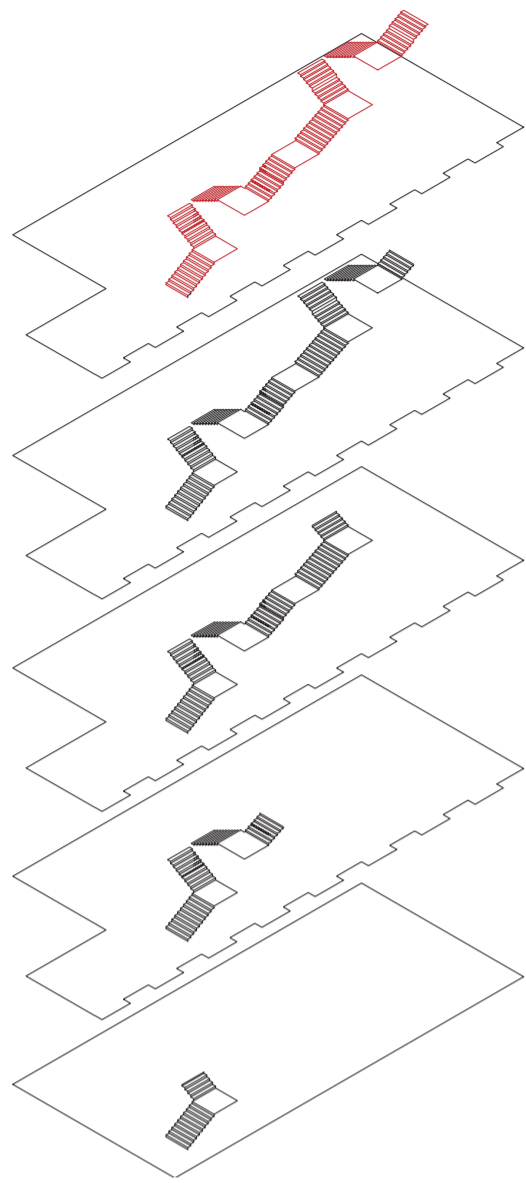

Jenga

Luca Anzanello
Alberto Drigo

Laboratorio di progetto 2E
a.a. 2021/2022

prof.ssa Esther Giani
prof.ssa Cristiana Cellucci

guest critic
prof. Giancarlo Carnevale

tutor
Alessio Tamiazzo
Valentina Covre

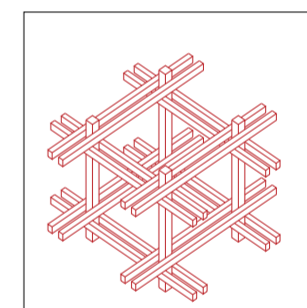
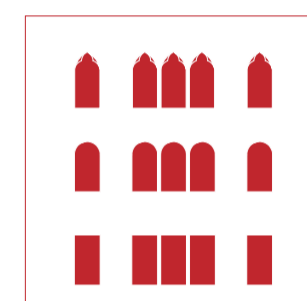
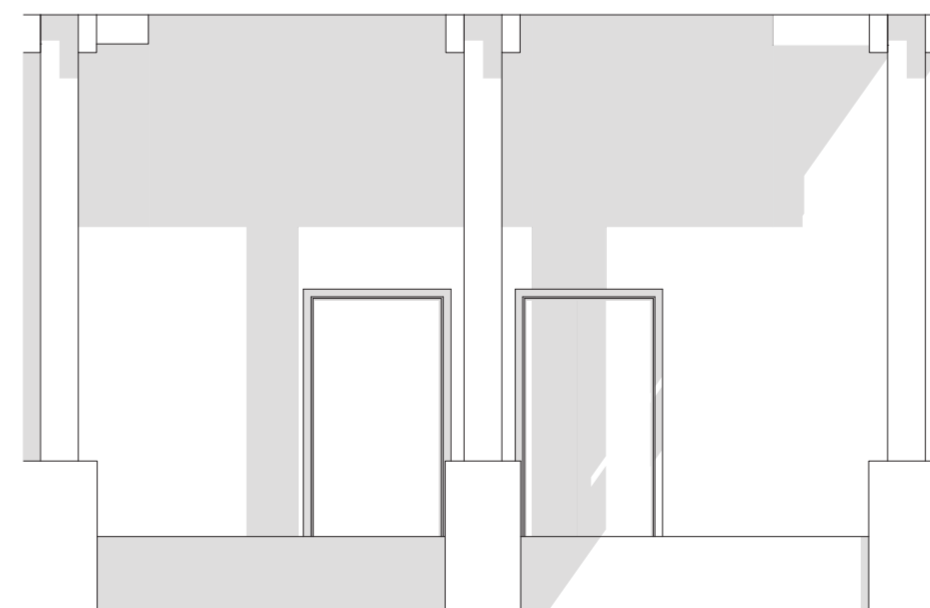
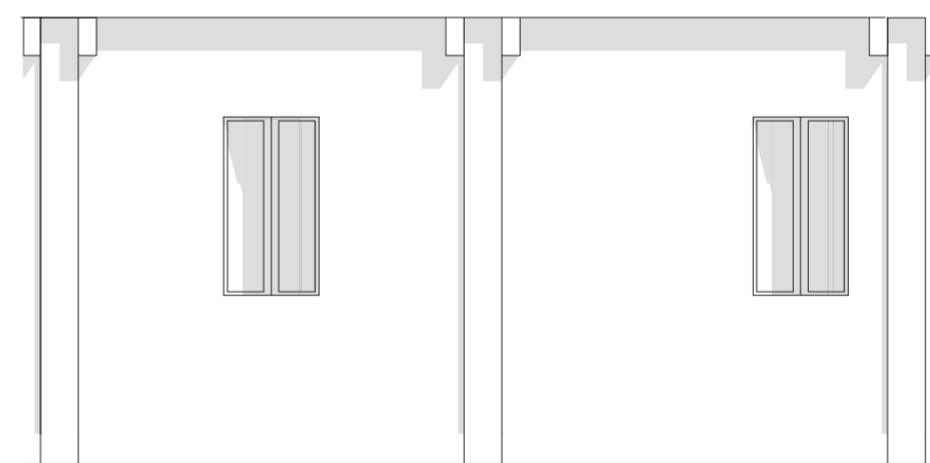
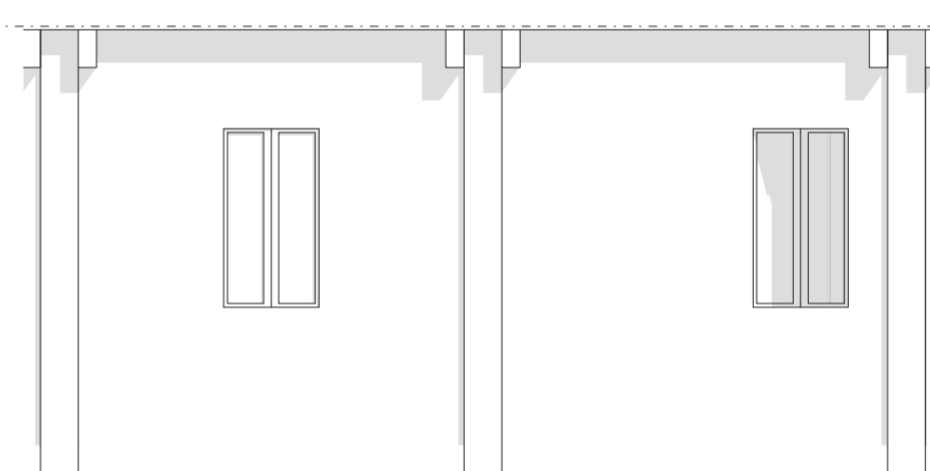
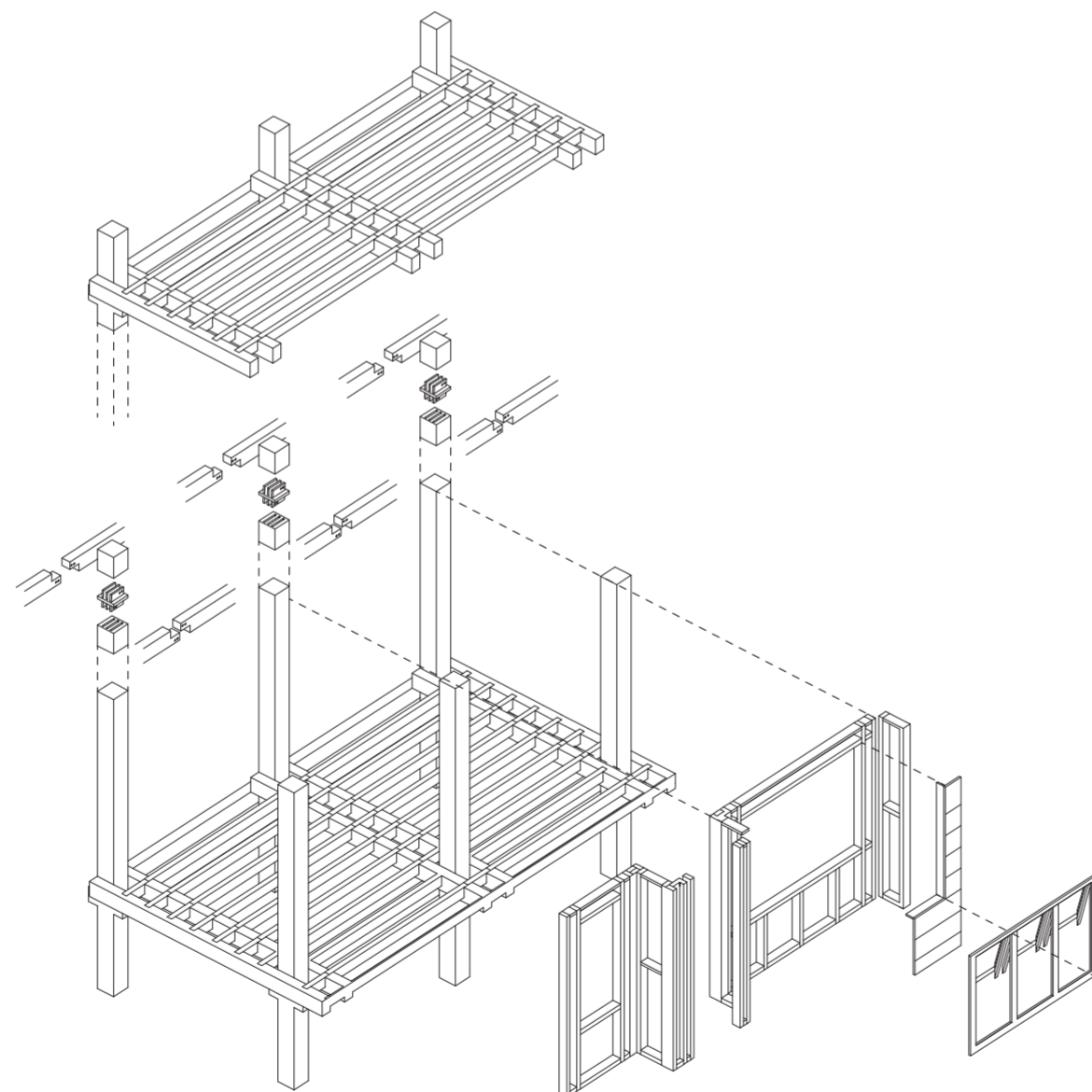
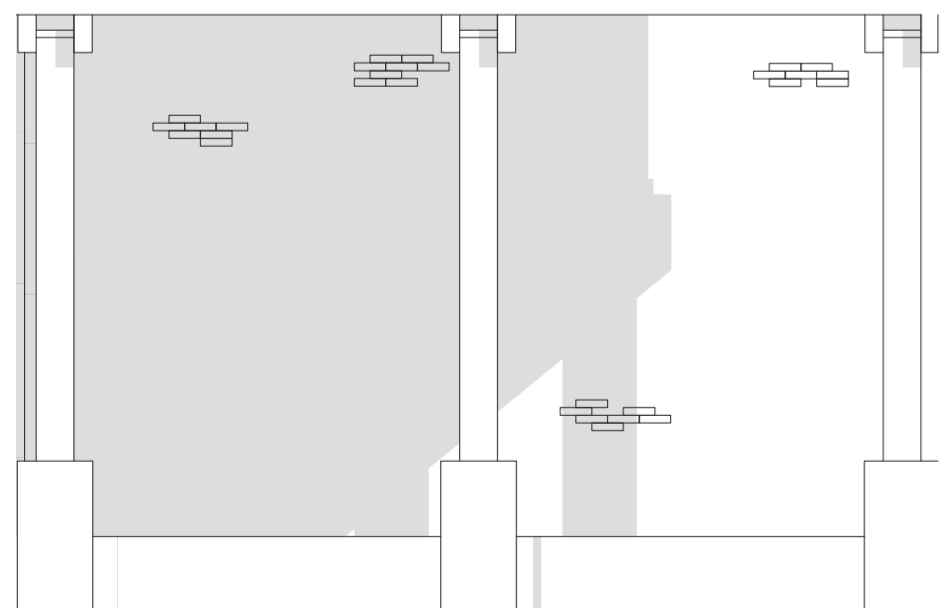
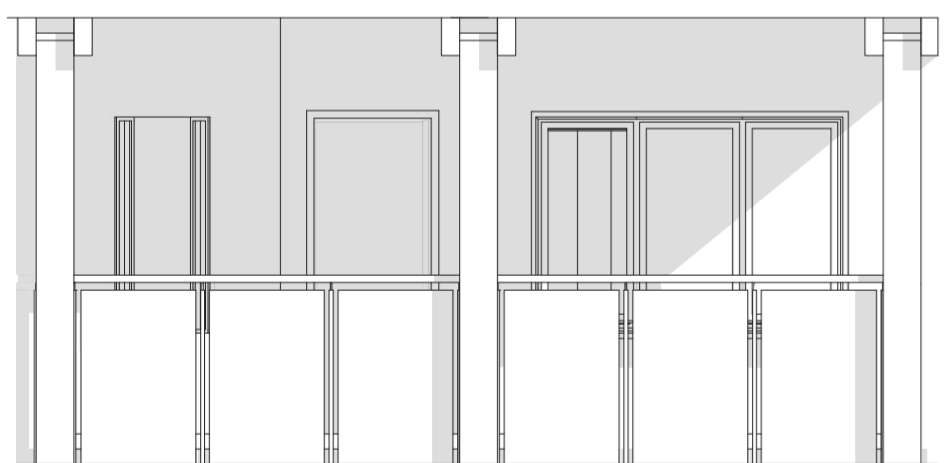
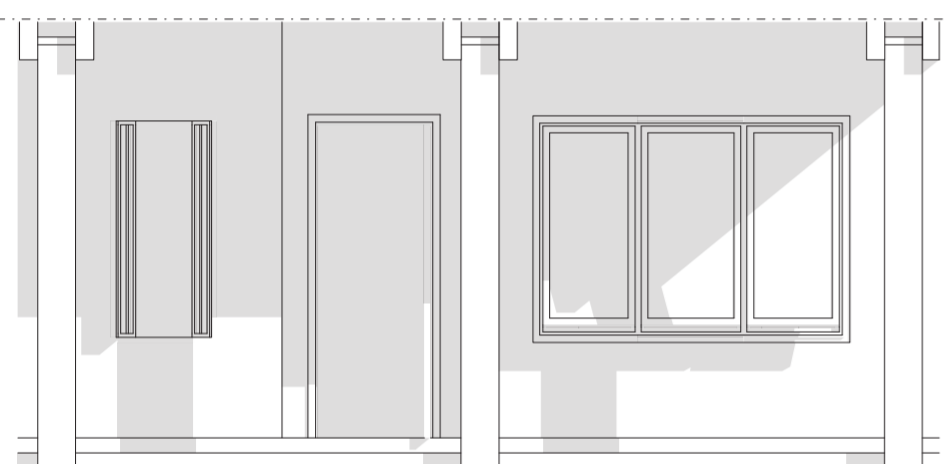
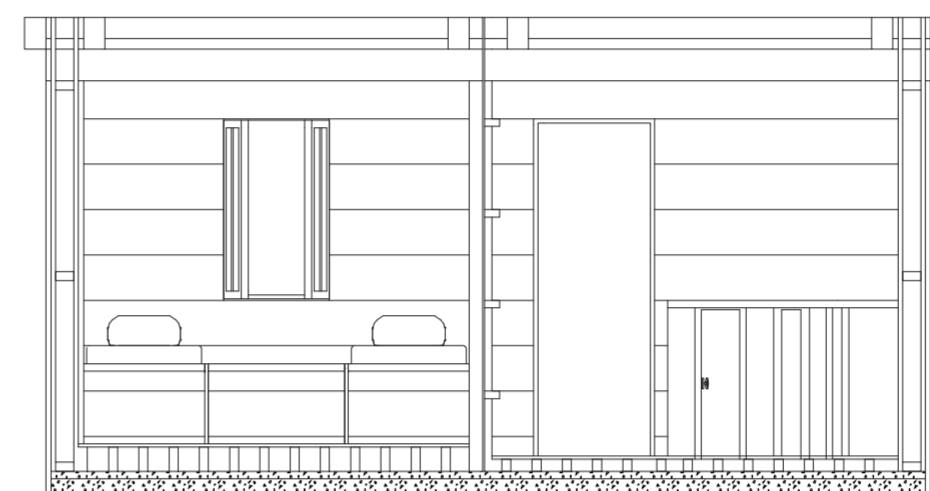
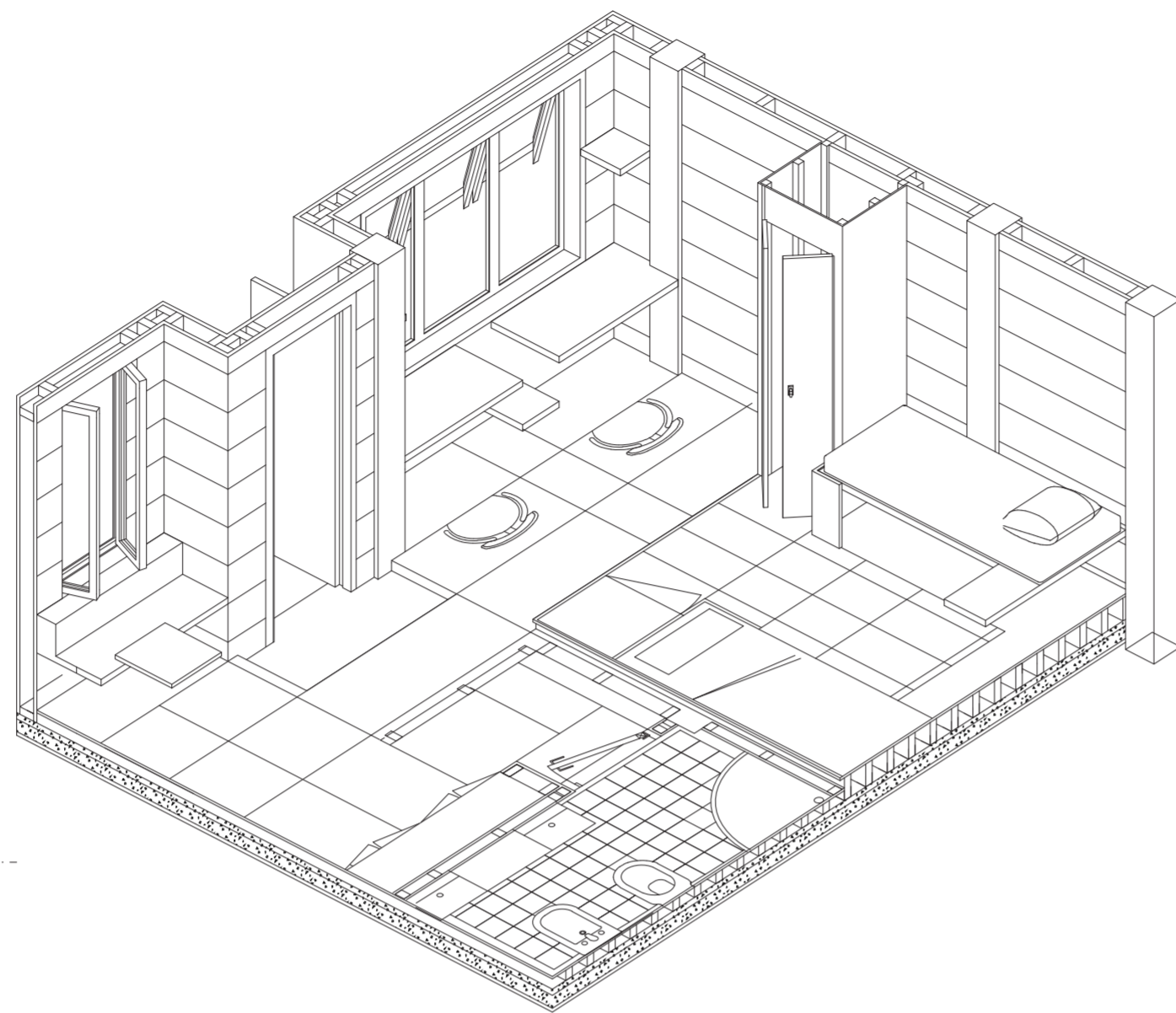
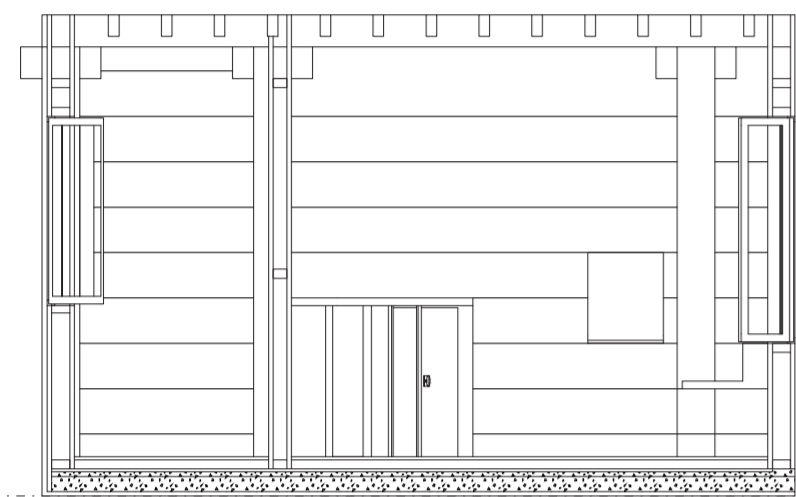

Jenga

Luca Anzanello
Alberto Drigo

Struttura portante:

- Travi e pilastri in legno
- Piastra ed elementi di fissaggio in acciaio

Struttura portata:

- Solaio:
- Orditura secondaria di travi in legno
- Tavolato in legno
- Massetto in cls
- Pavimentazione in legno

Parete verticale:

- Telaio in legno, montanti e traversi 12x8 cm
- Isolante termo acustico
- Impianti
- Infisso in legno

Laboratorio di progetto 2E
a.a. 2021/2022

prof.ssa Esther Giani
prof.ssa Cristiana Cellucci

guest critic
prof. Giancarlo Carnevale

tutor
Alessio Tamiazzo
Valentina Covre

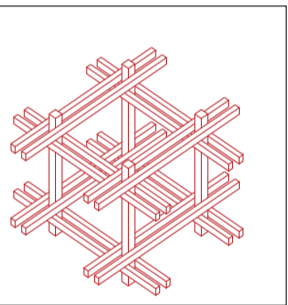
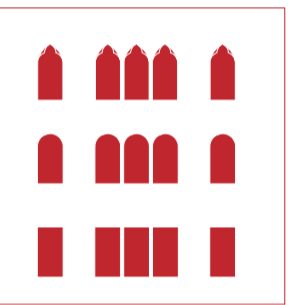
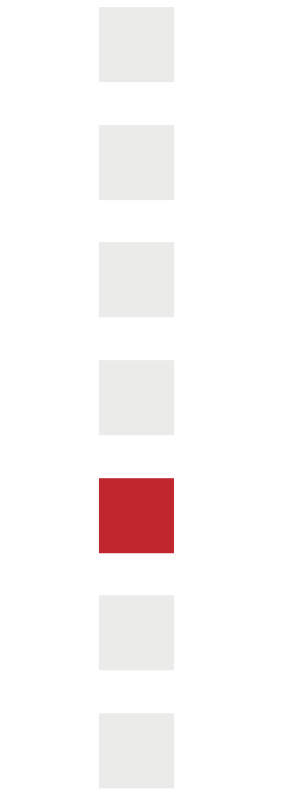
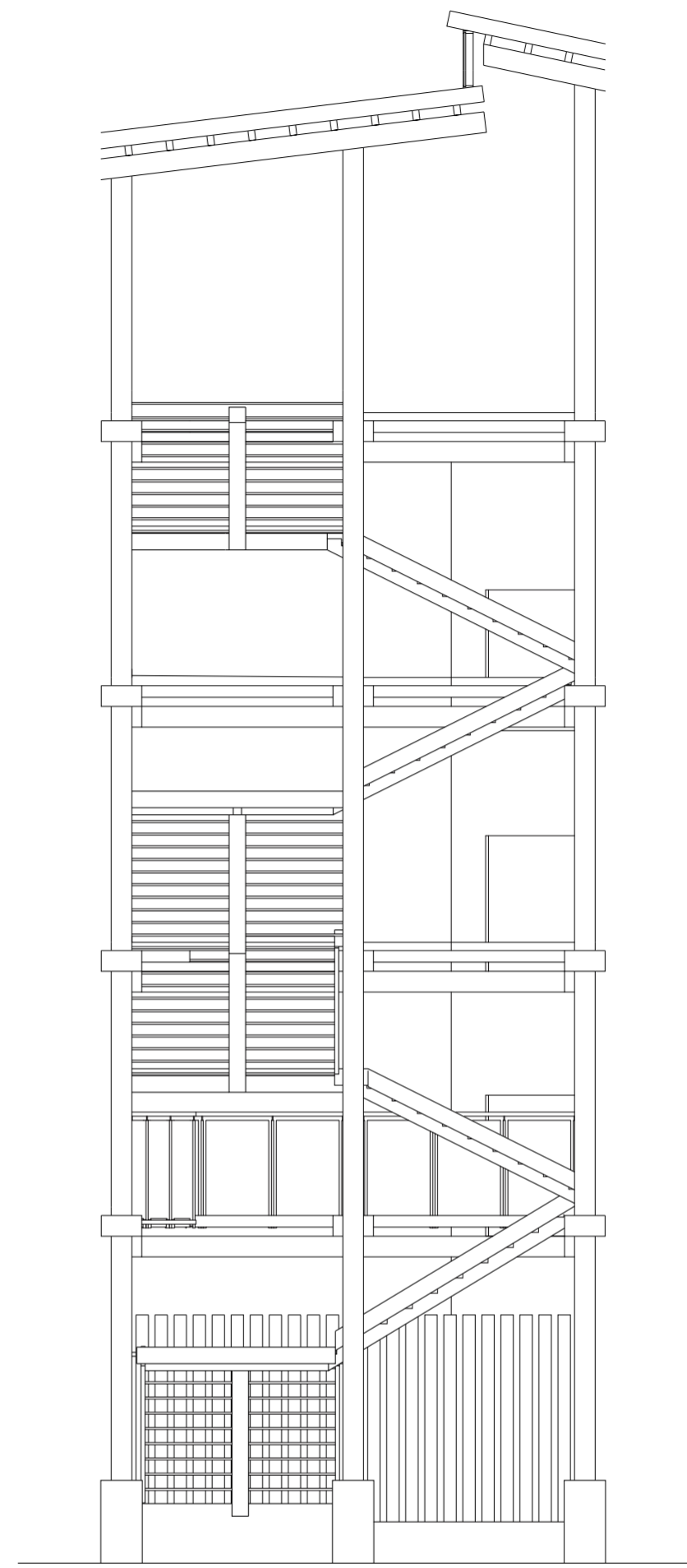

Jenga

Luca Anzanello
Alberto Drigo

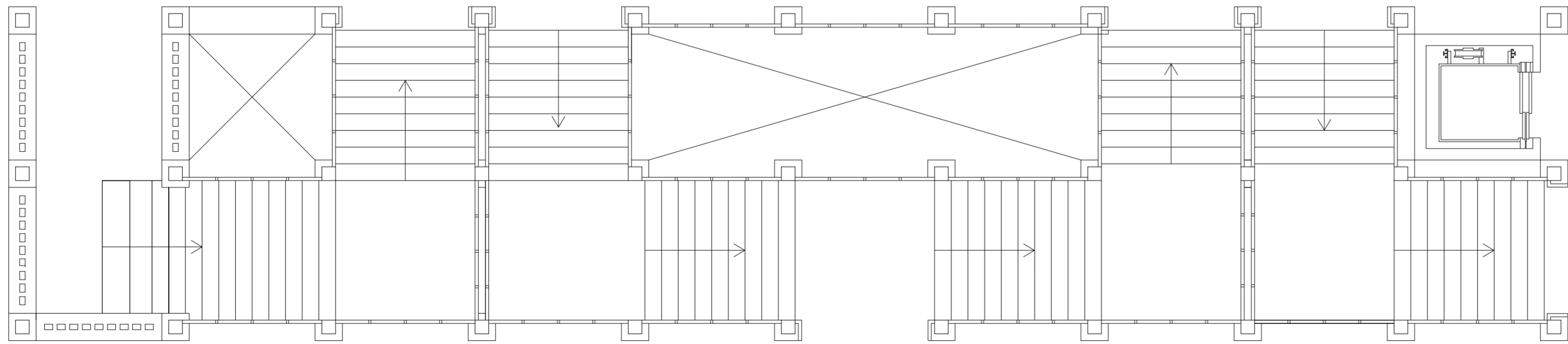

Laboratorio di progetto 2E
a.a. 2021/2022

prof.ssa Esther Giani
prof.ssa Cristiana Cellucci

guest critic
prof. Giancarlo Carnevale

tutor
Alessio Tamiazzo
Valentina Covre

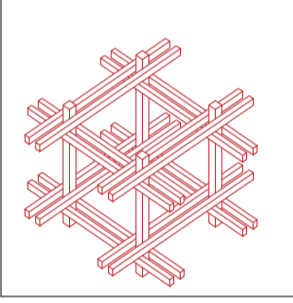
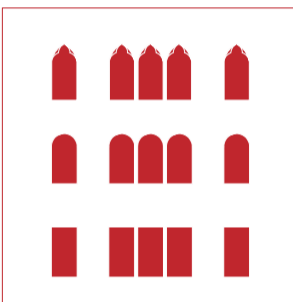

Jenga

Luca Anzanello
Alberto Drigo

Laboratorio di progetto 2E
a.a. 2021/2022

prof.ssa Esther Giani
prof.ssa Cristiana Cellucci

guest critic
prof. Giancarlo Carnevale

tutor
Alessio Tamiazzo
Valentina Covre

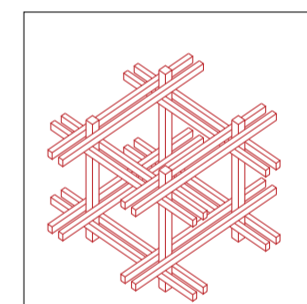
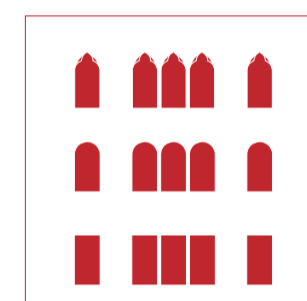
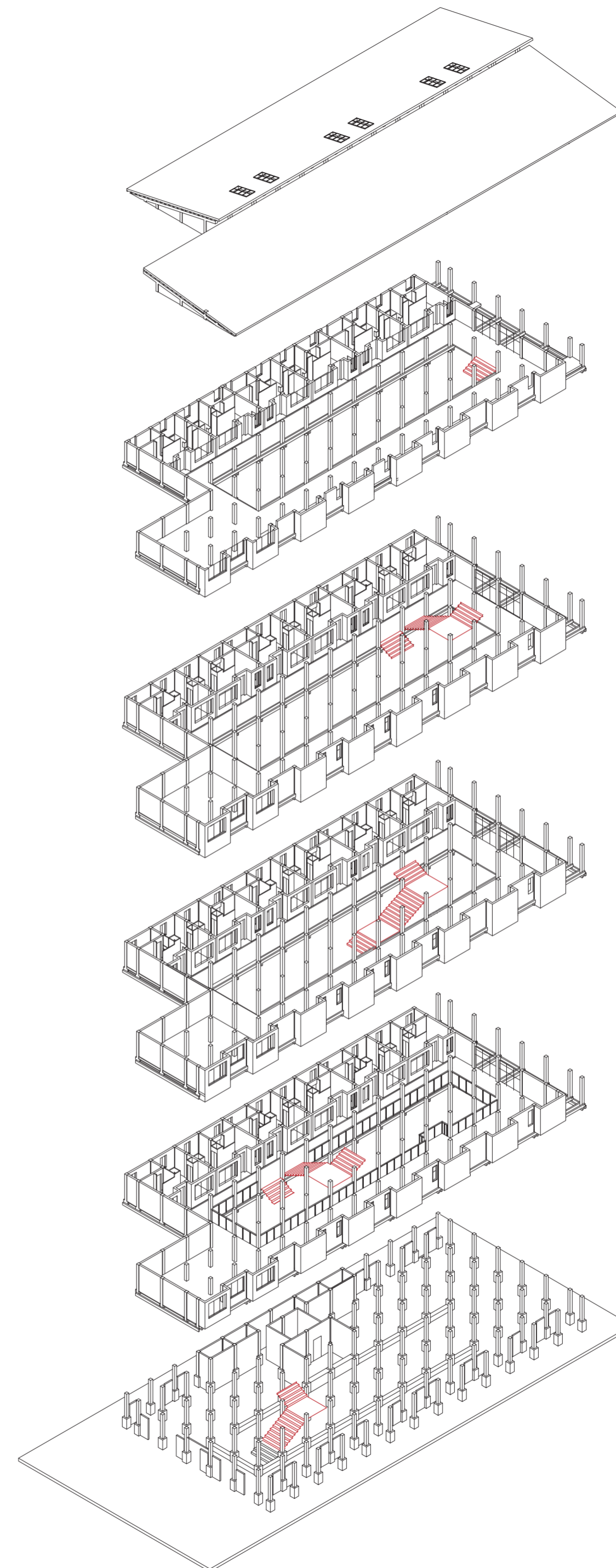

Jenga

Luca Anzanello
Alberto Drigo

Laboratorio di progetto 2E
a.a. 2021/2022

prof.ssa Esther Giani
prof.ssa Cristiana Cellucci

guest critic
prof. Giancarlo Carnevale

tutor
Alessio Tamiazzo
Valentina Covre